

RF, THERMAL AND STRUCTURAL ANALYSIS OF THE 57.5 MHz CW RFQ FOR THE RIA DRIVER LINAC¹

T.J. Schultheiss, J.W. Rathke,

Advanced Energy Systems, Inc. 27E Industrial Blvd., Medford, NY 11763

P.N. Ostroumov, A.A. Kolomiets²

Physics Division Argonne National Laboratory, 9700 S. Cass Ave., Argonne, Ill. 60439

Abstract

The RFQ design for the Rare Isotope Accelerator (RIA) driver operates at 57.5 MHz, room temperature and is CW, Continuous Wave. This device is capable of accelerating a variety of masses as well as simultaneously accelerating multiple charge states. Therefore, the structure must operate over a wide range of RF power dissipation, from less than 1kW to about 48 kW. The physics design was developed by ANL and the preliminary engineering design by AES. Some of its principal design requirements include efficient cooling of components, mechanical stability, precise alignment and fine tuning of the resonant frequency during operation. This paper discusses RF, thermal and structural analyses that have been completed in response to these requirements. RF analysis was used to determine the heat loss distribution on the cavity surfaces. The heat loads were then transferred to a thermal model of a single segment and scaled to match total heat loss obtained from the code CST Microwave Studio. The thermal model includes the cavity vanes, walls and all coolant channels. To determine the coolant temperature rise, one-dimensional pipe flow elements were used. These elements account for fluid heat transport and heat transfer coefficients. The model was then used to minimize coolant flow by connecting the shell coolant channels in series. Temperature distributions were used as input to the structural model to determine stress levels and vane displacements. Different power levels were assessed, as well as, the thermal and structural response to vane-shell coolant temperature differences which may be used to tune the resonant frequency. Results of these analyses show that the thermal and structural design of this RFQ is very robust.

1 INTRODUCTION

The Nuclear Science Advisory Committee (NSAC) has recommended the Rare Isotope Accelerator (RIA) as the highest priority for new construction in Nuclear Physics in the 2002 long range plan for Nuclear Science.

Many scientists and laboratories from across the country are contributing to research and development, the technical design, and the site concept for the proposed facility. The RIA driver accelerator is planned as a flexible device capable of providing up to 400 kW beams of ions from protons at 900 MeV to uranium at energies of 400 MeV per nucleon. The high power provides orders of magnitude improvement in isotope yield over existing or planned facilities.

2 REQUIREMENTS

The basic specifications of the 57.5 MHz RFQ are, continuous operation, small longitudinal emittance, stability from 1/70th to full power and acceleration of species from protons to uranium. In particular we require simultaneous acceleration of two charge-states of uranium ions [1]. The focus of the analysis was to develop a cooling scheme and determine the thermal and structural sensitivity to the range of power levels. Figure 1 shows an RFQ segment and its cooling channels. Details of the design effort for the RFQ can be found in [2].

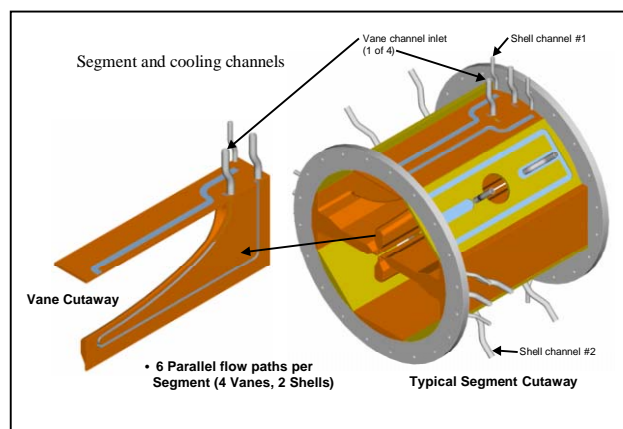

Figure 1: An RFQ segment with cooling channels

¹ Work supported by Argonne National Laboratory under Contract 2F-00301. ANL is supported by the U.S. Department of Energy, Nuclear Physics Division, under Contract W-31-100-ENG-38.

² On leave from the Institute of Theoretical and Experimental Physics, Moscow.

3 MODELING

Modelling that includes 3-D RF analysis has been expedited by using identical nodes and element connectivity at the RF/metal surfaces. This avoids having to map the RF generated heat loads onto the thermal model. However size limitations of the RF model can constrain the model size to a smaller but representative section. In this case we settled on one half of one segment. The finite element code ANSYS was used for all analyses.

A pictorial description of the analysis procedure is shown in figure 2. In the upper left corner the RF model is shown in light blue. The solid red is the RFQ structure. The RF analysis is used to determine the fields and heat loads are determined. Results are scaled to the

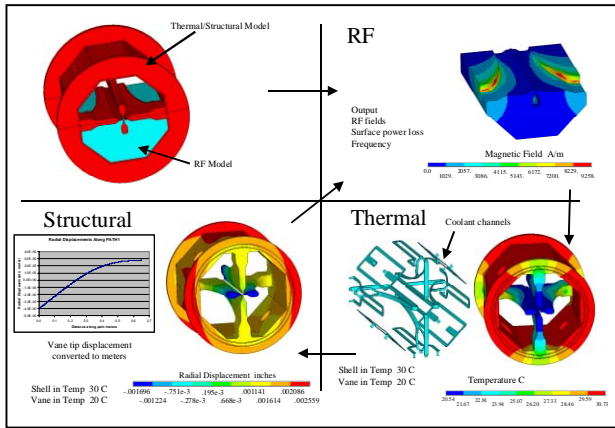

Figure 2: Simplified analysis procedure

appropriate field values, in this case to the inter-vane voltage. The loads are passed to the thermal model for temperature evaluation. The temperatures are likewise passed to the structural model to determine displacements and stresses. The resulting displacements are then used to evaluate frequency shift. Details are given in the subsequent sections.

4 RF ANALYSIS

The RF model was initially developed as a one quarter segment model. This should be sufficient assuming that the temperatures and displacements also have 4-fold

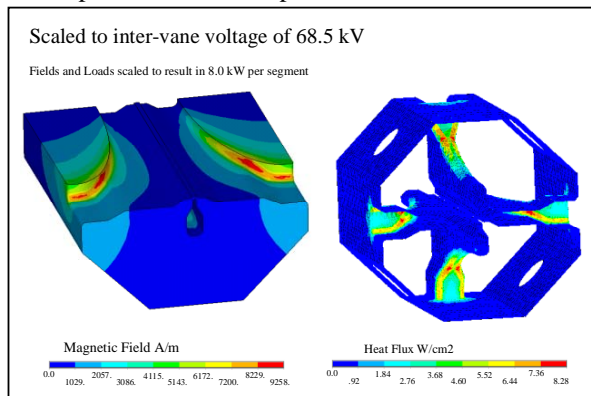

Figure 3: Surface magnetic field and heat flux

symmetry. After series cooling in the shell was implemented 2-fold symmetry was assumed in the RF analysis, (Fig. 3). The model size for a full segment was prohibitive.

The peak magnetic fields and heat flux are shown in figure 3 and occur on the curved vane surfaces.

5 THERMAL ANALYSIS

RF heat loads were passed to the thermal model and applied to the surfaces as heat flux. One dimensional fluid elements are included to determine the temperature rise of the coolant. The fluid elements are connected to the coolant surfaces via convection elements. Temperature distributions were determined for full power and 1/70th power with the coolant inlet of both the vane and shell fixed at 20 °C. Frequency tuning of the structure was considered by assuming an elevated shell inlet temperature. Figure 4, shows the temperature distribution of the water coolant assuming a 30 °C shell and 20 °C vane inlet temperature and the resulting

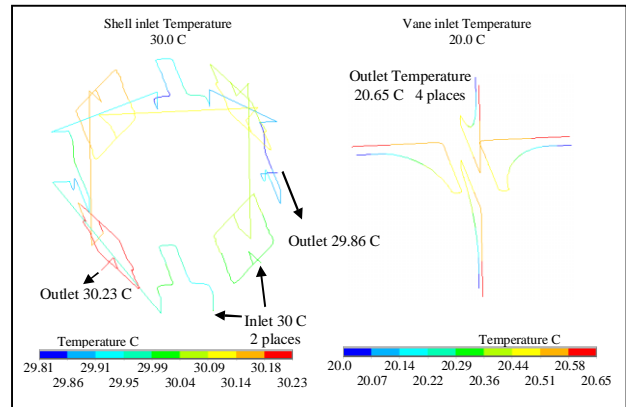

Figure 4: Coolant temperature distribution

structure temperature distribution shown in figure 5. The results show a very small coolant temperature variation, due to the large thermal mass of the water along with the counter flowing shell coolant paths, as shown on the left side of figure 4. The temperature distribution is passed to the structural model to determine displacements and stresses.

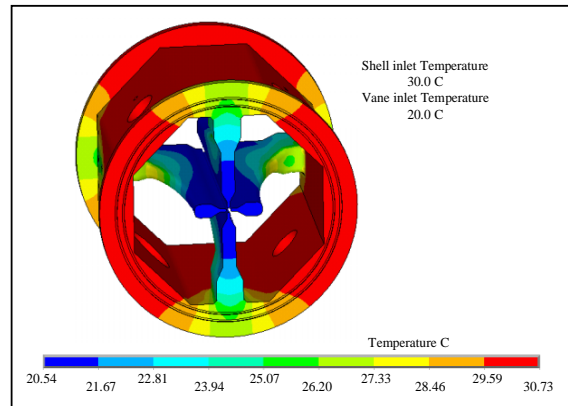

Figure 5: Segment temperature distribution

6 STRUCTURAL ANALYSIS

The structural model includes both pressure loads and temperatures. The coolant channel pressure is assumed to be 70 psi within all coolant channels. The outside of the structure is assumed to be at ambient pressure while the inside is under vacuum. To more accurately characterize the behavior with differential temperatures in the vane and the shell, the model includes “gap” elements where the vane ends meet. These elements transfer compression loads but may allow a gap to open (will not transmit tension). Because the shell runs at an elevated temperature relative to the vanes, there is a significant effect on the tuning results.

Results are shown for the 30 °C shell coolant inlet, 20 °C vane coolant inlet temperature and full power. Radial displacements of the segment are given in figure 6 and show that the cantilever design combined with the

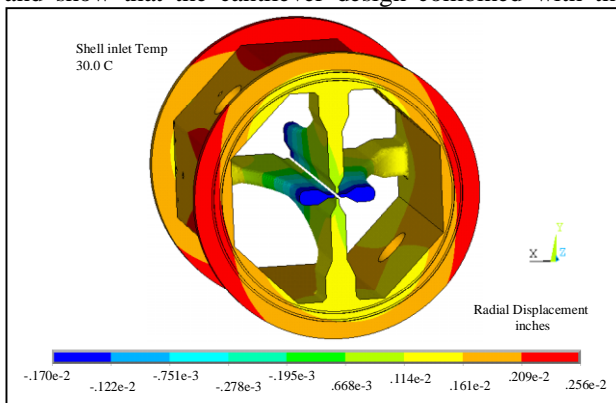

Figure 6: Radial displacements

temperature differences results in vane tip movement that varies axially and is dependent on relative location of the vane/shell interface.

The maximum von Mises stress (Fig. 7) is localized and occurs at the vane shell interface where the coolant inlet temperatures differ the most. The stress level is below 2500 psi for full power operation when the shell inlet coolant temperature is at 30 °C. Stress is not a design driver for this RFQ.

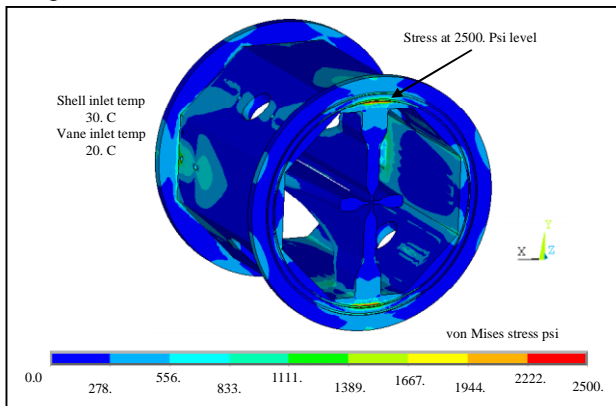

Figure 7: Segment von Mises stress

7 RF FREQUENCY SHIFT

With gaps included at the vane boundaries, the frequency shift is given in figure 8. A near linear relation exists for shell temperatures above 23 °C where the vane edges of adjacent segments separate. This curve shows a positive slope of +2978 Hz/ °C and a net zero frequency shift for a shell inlet temperature of 31.2 °C. For the 3-D frequency shift calculations the same mesh is used for all calculations with only the location of the surface nodes modified.

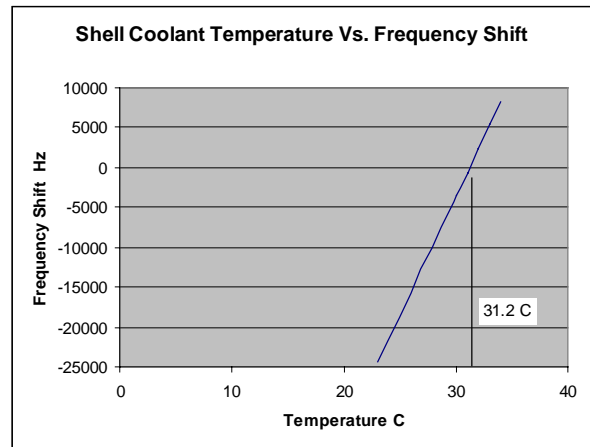

Figure 8: Frequency shift vs. inlet temperature

8 SUMMARY

RF Analysis - Heat Loads:	
• Wall Power Loss - Full Power	8 kW/segment
- Peak Power Density	8.28 W/cm ²
Thermal Analysis:	
• Temperature distribution for input into structural analysis	
- Maximum temperature in RFQ 20 C vane inlets, 30.0 C shell inlets	30.7 C
- Total Water flow for six segments - does not include end walls	332. gal/min
Stress and Displacement:	
• 20 C vane inlets, 30.0 C shell inlets	
- Cooling passage pressure 70. Psi	
- Ambient pressure on external surfaces 14.7 psi.	
- Results, largest vane tip radial displacement -.001685 in (-.0428 mm)	
- Stresses are < 2500. PSI (17.2 MPa)	
• Input resulting displacements back into RF Analysis to determine frequency shift	
RF Analysis - Frequency Shift:	
- Frequency Shift Full Power 20 C inlet, vanes and shell	-23.9 kHz
- Frequency Shift Full Power 20 C inlet vanes, shell 31.2 C inlet shell	= 0.0 kHz

9 REFERENCES

- [1] P. Ostroumov, et al, “Design Of 57.5 MHz CW RFQ for Medium Energy Heavy Ion Superconducting Linac”; Physical Review Special Topics Accelerator and Beams 5, 060101 (2002); <http://prstab.ab.sps.org/abstract/PRSTAB/v5/i6/e060101>
- [2] J. Rathke, et al, “Preliminary Engineering Design of a 57.5 MHz CW RFQ for the RIA Driver Linac”; paper ID TU466, These Proceedings.